

JA-65 "MAESTRO"

Alarm system - installation manual Zabezpečovací systém - instalační manuál

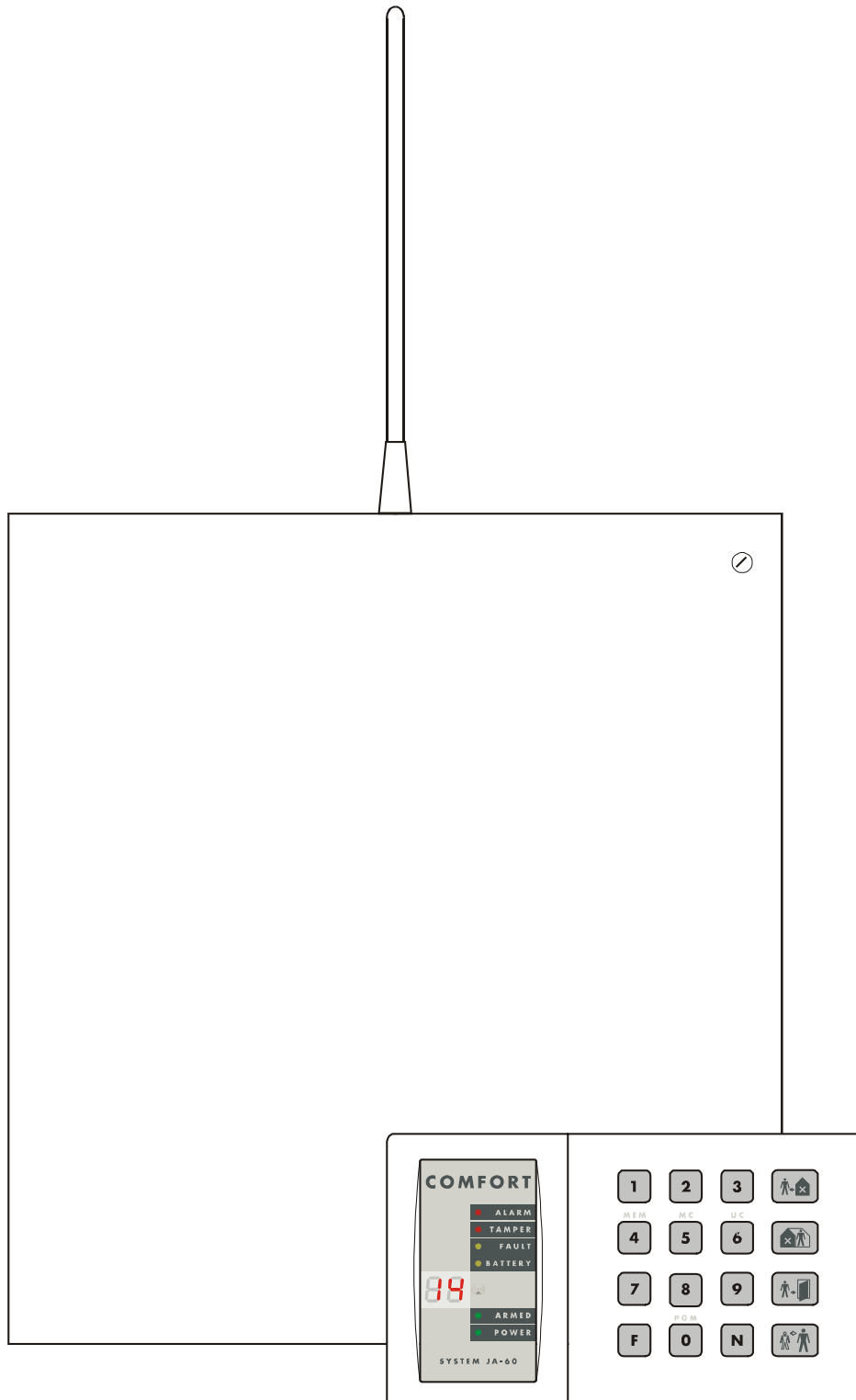

Contents:

1. Architecture of the control panel	4
2. Configuration of the control panel	5
3. Control panel installation	5
3.1. Power cable wiring	5
4. Antenna of the JA-65R module	5
4.1. Rubber antenna use in the control panel	5
4.2. External antenna use	5
5. Connectors and terminals of the main board	5
6. The JA-65H hard wired input module terminals	6
7. Wiring of the JA-60 keypad(s)	7
8. Installation of wireless items	7
9. Back up battery installation	7
10. First powering of the control panel	7
11. Control panel programming	7
11.1. Enrollment (teaching) of wireless items	9
11.2. Hard-wired zone input setting	9
11.3. Exit delay	9
11.4. Entrance delay	10
11.5. Alarm duration	10
11.6. PgX and PgY output functions	10
11.7. Recorded message and phone number editing in the user mode	10
11.8. Radio signal jamming testing	10
11.9. Regular communication checking	10
11.10. Reset enabled	10
11.11. Controlling of a subsystem	11
11.12. Enrollment of the control panel to a UC-2xx or to a master control panel	11
11.13. No code requested for F1, F2, F3, F4, F8 & F9	11
11.14. Partial (Home) arming with (F2) (non split control panel)	11
11.15. Hard wired siren alarm enabled	11
11.16. Exit delay audible indication	11
11.17. Partial arming exit delay audible indication	12
11.18. Entrance delay audible indication	12
11.19. Arming and disarming chirps with hard wired siren	12
11.20. Siren alarm in Disarm & Partial arming	12
11.21. Wireless siren alarm	12
11.22. Indication of system problems when arming	12
11.23. Control panel splitting	12
11.24. Only first source of alarm is recorded	12
11.25. Alarm triggered by opened zone when arming	12
11.26. Audible panic alarm	13
11.27. Next delay wireless detectors	13
11.28. Communication loss alarm	13
11.27. Entering the programming mode by SC+MC/UC	13
11.28. Addressing of wireless detectors to sections	13
11.29. Addressing of the user codes to sections	13
11.30. Addressing of wireless controllers to sections	13
11.31. Automatic arming / disarming setting	13
11.32. New service code setting	14
11.33. User Mode entering	14
11.34. Real time and date setting	14
12. System testing	14
13. Control panel factory default reset	14
14. Personal Computer Interface	15
15. Recommended Professional installer basic rules	15
16. Trouble shooting table	16
17. Possibilities to extend the system	16
17.1 Extension of the system with a subsystem	16
17.2 Extension of the system with a communicator	16
17.3 Brief overview of parts suitable for the JA-63 system	16
18. Control panel specifications:	17

This manual is valid for control panel model JA-65 versions FM61116 (control panel board).

The use of Comlink Windows v. 61 software or higher is required for this control panel and can be obtained from our home page at www.jablotron.com

This product is to be installed by professional installers only. The manufacturer assumes no liability for damages caused by incorrect installation or improper use of this system.

1. Architecture of the control panel

The JA-65 "Maestro" is a fully programmable control panel with building block architecture. This allows the JA-65 to be tailored to particular installation requirements. The Maestro can operate as a wireless, wired or combined system.

The JA-65K metal box has a built in electronic power supply. There is space for a 12V, 7Ah backup battery. The 16 zone control panel's main board is installed in the internal platform. The main board does not have any physical zone inputs. This allows you to configure the control panel by using the following modules:

- **Radio communicating module JA-65R** can enroll wireless items (JA-60): up to 16 detectors, up to 8 controllers (remote controls or wireless keypads), JA-60A wireless sirens and UC family wireless output modules.
- **Hard-wired input module JA-65H** has 8 input loops with programmable triggering (NC, balanced or double balanced)

and programmable reactions. Up to two JA-65H hard-wired input modules can be used in the control panel.

- **GSM dialer JA-60GSM** sends SMS messages, calls to predefined telephone numbers and plays audible warning, communicates with 2 CMS, allows remote access from a phone's keypad and can be set via web page.
- **Telephone communicator JA-65X** can communicate with a Monitoring Station, send voice messages and dial a numeric Pager. It can also communicate with a remote PC (using ComLink SW and a JA-60U modem).
- **Operation and programming** is possible via the JA-60E keypad (or by its wireless option, JA-60F). The control panel can also be operated by a RC-40, RC-22 or RC-60 remote control, by input loop or by a JA-60D wireless keypad. Operation and programming is also possible via a PC using ComLink SW.

This allows the JA-65 to operate as a wireless (16 detectors), wired (8 or 16 inputs) or combined system. An additional JA-63 or JA-65 subsystem control panel can expand the system. The control panel can be split in to two independent sections with a shared common area.

JA-60GSM - GSM module allows sending SMS along with audible warnings. Also it can simulate telephone line and communicate with two CMS.

JA-65X - telephone communicator module combines a digital modem for monitoring station or remote PC communication, a voice multi-message and Pager dialer. The connected telephone line signal is supervised by the control panel. The module has TBR21 international approval.

JA-65R - radio communicating module allows the enrollment of wireless: detectors (16), controllers & keypads (8) and wireless siren (1) - all of JA-60 family. The module can also control UC wireless output receivers. It can be used with a rubber rod antenna or with an optional external antenna.

JA-65K - the control panel's steel case has a built-in power supply, space for a battery (up to 7Ah) and the control panel's main board. This board has 10 output terminals (power, siren, alarm relay, programmable outputs X and Y). There is also a pair of digital data jacks to connect the JA-60E keypad or a PC equipped with ComLink SW. The digital data is available on terminals as well. The main board also has connectors for input modules (R, H) and for a telephone communicator module (GSM or X)

JA-65H - hard wired input module has terminals to connect 8 input loops. The method of triggering and its reaction is programmable for each zone. Up to two 65H modules can be used in the control panel (i.e. max. 16 hard wired zones).

The control panel can be **operated and programmed** by the JA-60E keypad(s) - up to 5 of them can be connected. The system can also be operated and programmed using JA-60F wireless keypads. Arming and disarming is also possible using RC-11 remote controls or wireless JA-60D keypads (up to 8 wireless controllers can be enrolled).

Power supply - is a part of the basic JA-65K case. Mains power 110 - 250VAC can be wired directly to this unit. The unit powers the control panel itself, as well as any wired external devices and it also charges the backup battery. The power supply and the backup battery are supervised by the system

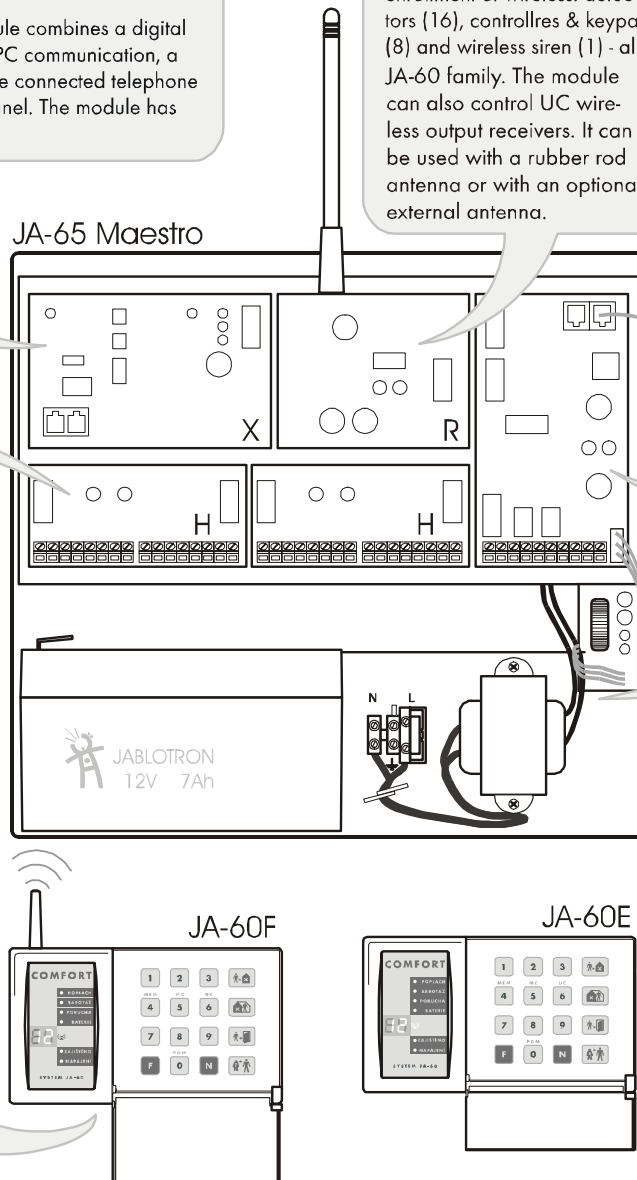

2. Configuration of the control panel

The metal case of the JA-65K control panel is shipped from the factory with a built-in power supply unit and the main board. To be able to work as an alarm system, it should be equipped with interface modules (R, H, X, GSM) in the following way:

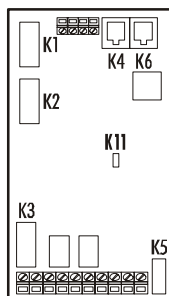

- open the case and remove the cover
- disconnect the power unit cable from the main board connector K5
- unscrew the module platform (screw on the left side)
- open the platform and remove it from the case
- attach the desired modules to the positions shown in the previous diagram
- connect the modules' cables to the main board in the following way:
 - 60GSM or 65X = K1
 - 65R = K2
 - 65H = K3 (if two 65H modules are used, connect the left module cable to the right 65H module and the right module cable to the main board's K3 connector)

3. Control panel installation

The control panel's case is designed to be attached to the wall, or it can be partly installed into the wall. The rectangular hole on the back side is for cable routing. The hole matches a KT-250 standard junction box. This allows easy specification on how to prepare cables in a house before an alarm system installation.

- If the **65R radio-communicating module** is used, keep in mind that the **antenna will need about 20 cm of clearance**. The 65R module comes with a rubber antenna, but it can also be used with an external antenna, model AN-01. The working range of the wireless accessories is about 100 meters under optimal conditions. However, building materials can absorb or obstruct radio signals and communication can also be effected by interference from other radio signals. For these reasons, you should anticipate a shorter working range for indoor installations.
- **Route all the cables** to the control panel (power, input loops, outputs, telephone line etc.) before you attach the case to the desired location.

Note: if you install the case in the wall, the hinges for both the cover & module mounting platform should not be placed within

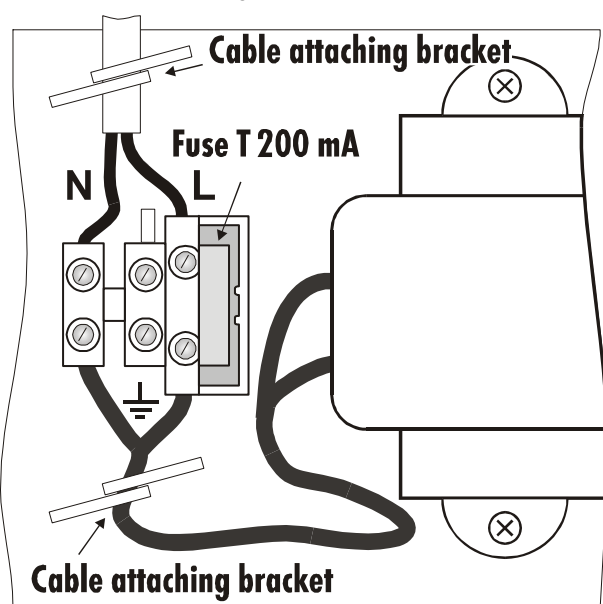

the wall.

3.1. Power cable wiring

The power cable should be connected only by a licensed electrician. The control panel is an electrical safety class II. device with double insulation and power to its power unit must be wired with double insulated two core power cord. No power wire should be connected to the metal case.

Instructions:

- use flexible 2 core (size from 0.75 to 1.5 mm²) double insulated power cord. The system should not share a fuse (10 A max) with any other household item. The fuse is used as a circuit breaker too.
- Attach the cable firmly to the board using the metal brackets. Before you tighten the brackets, check that the wires are tightly screwed in the terminals L and N and be sure that the wires are not longer than shown in the diagram.
- Check connection of the power unit cable to the connector K5 on the main board.

4. Antenna of the JA-65R module

If the JA-65R module is installed, it will be possible to enroll wireless detectors, controllers, a JA-60A siren, output modules and another wireless subsystem if required. Enrollment is described in the part 11.1. The 65R module must be equipped with an antenna.

4.1 Rubber antenna use in the control panel

There is a hole on the top of the control panel case (remove the plastic cap) for the rubber antenna. The rubber antenna is supplied with the 65R module. Install the antenna after the module mounting platform is inserted and screwed inside the control panel case.

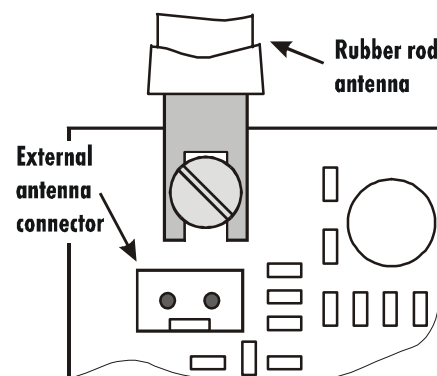

Attach the antenna to the 65R board using a screw as shown in the diagram. The antenna must not be obstructed by any large metal object.

4.2 External antenna use

An optional external antenna, model AN-01, can be used with the 65R module. This antenna has a connector, which fits the connector on the 65R module. If you use the external antenna, the rubber antenna should not be installed. The AN-01 antenna has a small plastic ring on its end, used to hang it from the wall. Its active part (from the plastic ring to the coil) should be installed vertically and should not be obstructed by any large metal object. The antenna can be located behind furniture, etc.

5. Connectors and terminals of the main board

In addition to the interface module connectors (K1, K2 and K3) the main board has the following connectors:

K5 - power supply connector: the cable from the power unit is connected to this connector. **Do not manipulate with the connector when it is powered.**

K4, K6 - digital data jacks for the JA-60E keypad(s) and/or for a PC interface cable. Up to five JA-60E keypads can be connected to a JA-65 and the maximum length of the cable can be 500 meters. We recommend use of a CT-04 cable and RJ-44 (Jablotron) crimping connectors to make the keypad cables. The digital data is also available on the terminals: see the following description.

1,2,3,4 - digital data terminals (see K4, K6) provide an option to use standard cable for the wiring of JA-60E keypads. The keypads are also equipped with both jacks and terminals.

The following terminals are on the bottom side of the main board:

- TMP** a pair of terminals to connect the tamper switch of an external device (for example: a wire operated outdoor siren, OS-300). In normal use, these terminals should be connected together via a 2k2 resistor. Triggering of this loop has the same effect as control panel tampering (a change of $\pm 30\%$ or more of the End Of Line resistor will trigger the input).
- PGX** is an output (transistor switching to GND, max. 12V, 100mA). The function of this output is determined by the setting in the programming mode (see 11.6). The control panel also wirelessly transmits the PGX signal and unit UC-216 or UC-222 can be used as a remote output of this signal.
- PGY** is an output (transistor switching to GND, max. 12V, 100mA). The function of this output is determined by the setting in the programming mode (see 11.6). The control panel also wirelessly transmits the PGY signal and unit UC-216 can be used as a remote output of this signal.
- C** is a common contact of the alarm output relay, max. load 60V / 1A. The relay is turned on during any alarm of the control panel.
- NC** is a normally closed contact of the alarm output relay.
- NO** is a normally open contact of the alarm output relay.
- GND** is a common ground terminal of the power output (-). This terminal is also available on 65H modules.
- SIR** is an external siren output. In the normal mode it has the +U terminal voltage. In the alarm mode it has a GND terminal potential. Connect an ordinary external siren to +U and SIR terminals (max. load 0,7 A). A back up siren

charging input should be connected to the GND and the SIR terminals (during an alarm, the charging will temporarily halt). The siren can also be used for sounding arming and disarming chirps and as an audible indicator while in the testing mode.

+U is a back up power output for external items (detectors etc.). The max. permanent current is 0.7 or 1.2 A for max. 15 min (not more then one cycle per hour). This output is fused and supervised by the control panel. If it is overloaded, a control panel failure will be indicated (fault C). The multiple +U terminals are also available on the JA-65H hard-wire modules for easier wiring. All +U terminals are connected in parallel to the +U terminal of the main board.

6. The JA-65H hard wired input module terminals

Up to two 65H modules can be used in the control panel. The module with its cable connected directly to the main board provides zone inputs 1 to 8. If the second module is installed it will provide zone inputs 9 to 16. The 65H module has the following terminals:

- 1 to 8** zone inputs – Normally, detector outputs are wired here: see examples of wiring in diagram. For each input it is possible to program its method of triggering: Normally Closed loop, balanced loop (10k) or double balanced loop (2x 10k) and the type of reaction of the system (see section 11.2).
- COM** Four common terminals to close (balance) the input loops
- GND** ground (negative pole) of the power supplier
- +U** backup power output for external devices (detectors etc.), max. total consumption from all +U terminals in the control panel can be 0,7 A.

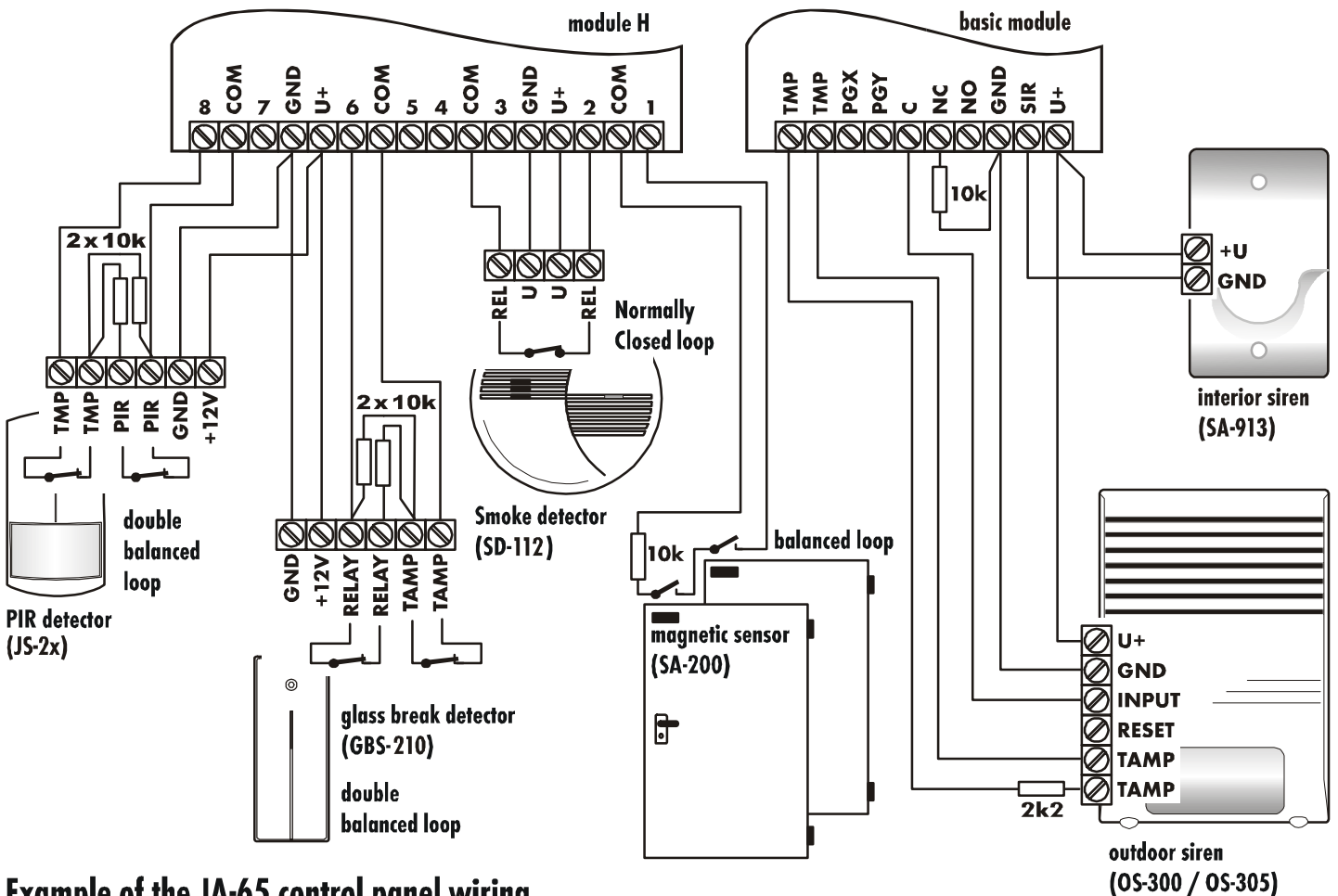

Example of the JA-65 control panel wiring

7. Wiring of the JA-60 keypad(s)

The system can be programmed and operated by JA-60E keypad(s). As a maximum, 5 keypads can be wired to the control panel. The keypads can either be wired by cables equipped with modular jacks to connectors K4 and K5 or by standard cables to terminals 1,2,3 & 4 on the main control panel board. The same numbered terminals (pins in the connectors) must be linked together. It is possible to combine arbitrary wiring with modular connectors and ordinary cables - see diagram.

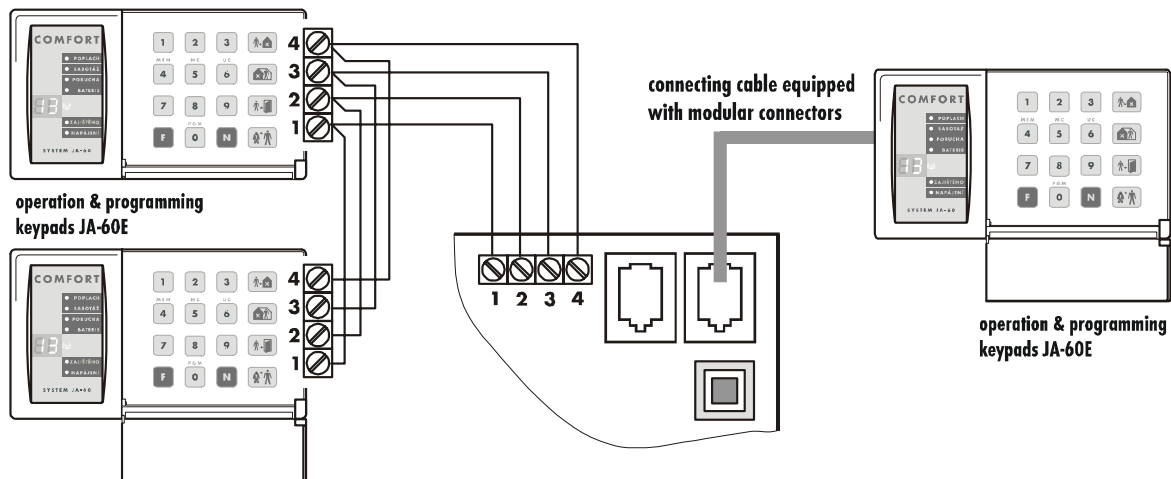

8. Installation of wireless items

If the control panel is equipped with a JA-65R module, it can work with all types of JA-60 wireless items and wireless UC output modules (see brief overview of items in enclosed catalogue).

- **Detectors** - one wireless JA-60 detector can be enrolled to each control panel zone (i.e. up to 16 detectors)
- **Keypads and remote controls** - up to 8 wireless controllers can be enrolled to the control panel (JA-60F and JA-60D keypads, RC-40, RC-22 and RC-60 remote controls)
- **JA-60A Wireless siren** - only one can be enrolled to a control panel – position A (next JA-60A can be enrolled to detectors positions)
- **wireless output modules UC-216 and UC-222** have relays, which copy the status of the control panel's programmable outputs PgX and PgY. An unlimited number of the UC modules can be used with each system.

Follow the particular wireless item manual when installing. After you install the item to desired location, leave it unpowered and without its cover. The method of enrollment is described in section 11.1.

9. Back up battery installation

there is a space for size 12V, 7Ah battery. According to the desired backup period a 12V back up battery from 1.3Ah to 45Ah can be used instead. A battery larger than 7Ah must be installed in an external case and the case must be equipped with tamper protection.

The control panel recharges and checks the condition of the back up battery. If the system is powered from the battery for a long time and the battery is nearly discharged, the control panel will first trigger a technical alarm and it will then disconnect the battery to prevent damage. After the main power is on again, the battery will be re-connected and will automatically re-charge.

For battery back up time calculation use the following stand-by consumption rates:

module JA-65R	20mA
module JA-65X	12mA
module JA-65H	15mA
main b. JA-65K	10mA
keypad JA-60E	25mA
Module JA-60GSM	50 mA

When a control panel has a JA-65R radio communicating module installed, it can also be operated and programmed via JA-60F wireless keypad(s) asunder this situation, a minimum of one JA-60E keypad should be connected to the control panel. With a 65R module, the system can also be operated by remote controls RC-40, RC-22 & RC-60, as well as by a JA-60D wireless keypad. The control panel can have up to 8 wireless controllers.

It is also possible to operate and program the JA-65 system via a connected PC with SW ComLink. The PC can be connected locally with a PC-60A or PC-60B interface cable or remotely, using a JA-60U modem if JA-65 module is installed.

- insert the battery into the control panel
- connect the battery cables (red +, black -)

Warning - do not make any short connection of the battery terminals!

10. First powering of the control panel

- Check that all cables are connected correctly
- Switch on the AC power
- The JA-60E keypad will display a "P", confirming that the system is in the programming mode (for system setting, enrollment of wireless items and for testing).
- If the JA-60F keypad is used, see 11.1 how to enroll it





Note: if „P“ is not displayed, the control panel is not in the factory default setting. Perform a Factory default reset. (See section 13).

11. Control panel programming

Functions of the system can be customized. The most convenient programming method is via a connected PC using the Comlink software (see 14). Programming can also be performed by entering programming sequences from the system keypad while in the programming mode:

- If the control panel is not in the programming mode, open it (entering **F 0 SC** - SC = Service Code, factory default SC=6060) – The programming mode will be indicated by a „P“ on the LED display. This mode can only be entered when the panel is disarmed. In this mode, no alarm can be triggered. Detectors and other accessories can be enrolled, the system parameters can be set up and the system can be tested.
- The parameters of the control panel can be set by entering programming sequences from the keypad. Any unfinished programming sequence can be terminated by pressing the **N** key.
- **To exit the programming mode, press the N key** („P“ will turn off). If any fault is indicated when you try to exit the programming mode, the control panel will inform you of the problem (see programming sequence 39x for more details).

List of control panel programmable parameters

Function	sequence	options	factory d.	note
Enrolling of detectors and controllers	1	1& 7 scroll, 2 erase pos., 3 controllers, 4 all	-	w. R module only
Hard-wired zone input setting	60 nn xyz	nn- zone n., x- triggering, y- reaction, s- section	all off	w. H module only
Exit delay	20x	x = 1 to 9 (x 10sec.)	30sec.	
Entrance delay	21x	x = 1 to 9 (x 10sec.)	30sec.	
Alarm duration	22x	x = 1 to 8 (min.), 0=10s, 9=15min	4min.	
Function of PgX output	23x	x = 0 to 8 (0-Chime, 1-Fire, 2-Arm, 3-Panik, 4-Alarm, 5-Door, 6-Home, 7-No AC, 8-Phone)	Chime	split system has different setting
Function of PgY output	24x	x = 0 to 8 (0-Chime, 1-Fire, 2-Arm, 3-Panik, 4-Alarm, 5-Door, 6-Home, 7-No AC, 8-Phone)	Arm	split system has different setting
Voice m. & tel. Numbers editable in the user mode	25x	251 = YES 250 = NO	NO	w. X module only
Radio signal jamming regular testing	26x	261 = YES 260 = NO	NO	w. R module only
Regular communication check enabled	27x	271 = YES 270 = NO	NE	w. R module only
RESET enabled	28x	281 = YES 280 = NO	YES	
Subsystem arming enrollment	290	will enroll to sub-control panel as wireless controller		w. R module only
Control panel enrollment to a UC-2xx, subsystem,...	299	will send enrolling signal		w. R module only
No code requested (effects  ,  ,  , F4, F8 & F9)	30x	301 = YES 300 = NO	YES	
Partial (Home) arming enabled ()	31x	311 = YES 310 = NO	YES	
Siren alarm enabled	32x	321 = YES 320 = NO	YES	
Exit delay audible indication enabled	33x	331 = YES 330 = NO	YES	
Partial arming exit delay audible indication	34x	341 = YES 340 = NO	NO	
Entrance delay audible indication enabled	35x	351 = YES 350 = NO	YES	
Arming & disarming chirp sounds enabled	36x	361 = YES 360 = NO	NO	
Siren in Disarm & Partial arming enabled	37x	371 = YES 370 = NO	YES	
Wireless siren alarm enabled	38x	381 = YES 380 = NO	YES	w. R module only
Indication of system problems when arming	39x	391 = YES 390 = NO	NO	
Split control panel (A, B & C sections)	690x	6901 = YES 6900 = NO	NO	
Only first source of alarm is recorded	691x	6911 = YES 6910 = NO	NO	
Alarm triggered by opened zone when arming	692x	6921 = YES 6920 = NO	NO	only if 391
Audible panic alarm	693x	6931 = YES 6930 = NO	NO	
Next delay wireless detectors	694x	6941 = YES 6940 = NO	NO	
Communication loss alarm	696x	6961 = YES 6960 = NO	YES	
Entering the programming mode by SC+MC/UC	697x	6971 = YES 6970 = NO	NO	
Addressing of wireless controllers to sections	63 nns	nn- controller n., s- section	all A	split & R module
Automatic arming/disarming setting	64nahhmm	n- 0-9, a-action #, hh-hours, mm-min.	all off	
New Service Code setting	5 nSC nSC	nSC = new Service Code	6060	enter code twice
Real time and date setting	4 hh mm DD MM RR		00 00 01 01 00	
User Mode entering	6999	Switching to the User mode	-	

11.1. Enrollment (teaching) of wireless items

enter: 1

If the control panel has a 65R module, as a maximum 16 wireless detectors and 8 controllers (remote controls & keypads) can be enrolled to the control panel. A wireless siren and an additional JA-60 or JA-65 control panel (a subsystem) can be enrolled as well.

- **Press key 1** (while „P“ is displayed) to enter the enrolling mode. The control panel will display the next free position to enroll a detector.
 - **If no JA-60E keypad is used in the installation** and you need to enroll a wireless JA-60F keypad:
 - connect (short) the RESET pins on the control panel board it will open the learning mode (tamper in the control panel must remain opened)
 - install batteries to the JA-60F keypad and wait until the keypad enrolls. Enrollment will be confirmed on the keypad.
 - disconnect the RESET pins and then use the keypad to enroll all the other items in following way
- **Use key 1 and 7 to scroll** (up and down) all control panel wireless positions – 1 to 16 (detectors) – c1 to c8 (controllers & keypads) – A (wireless siren) – J (sub control panel JA-6x). The display shows the position number while the Battery LED indicates if the position is occupied. The system will not allow enrollment of an item into a non-corresponding position (a detector can not be enrolled into a controller position etc.).
- **Detectors and keypads** are automatically enrolled when their power is switched on (batteries are installed). A remote control is enrolled only after both of its buttons are simultaneously pressed and held for 3 seconds. A subsystem control panel will enroll after sequence 299 is entered while it is in its programming mode. The system will not allow enrollment of an item into a non-corresponding position (a detector can not be enrolled into a controller position etc.).
- **Control panel confirms enrollment** with a „beep“ (press F to select a louder “beep” sound). The LED display will show the number of the enrolled item for 2 seconds and then it will display the number of the next free position.
- **To change the position** of an enrolled item is simple. **Enroll it to the new selected position** (the item will „move“). If you enroll an item to an occupied position, the former item will be deleted and only the new enrollment is valid. Only one item (detector, controller etc.) can be stored to each position.
- **Erase an enrolled item** the following way: in the enrolling mode select the corresponding position and then press and hold key 2 for two seconds. The item will be erased (confirmed with a long beep). If you press and hold key 3, all enrolled controllers (remote controls and keypads) will be erased. Pressing and holding key 4 will erase all enrolled items (detectors, controllers, siren and the sub system).
- **The JA-60A wireless siren will generate an enrollment signal** when its power is switched on (it will enroll to position A). If you need to enroll a siren which is already powered and it is not possible to easily switch off its power, you can enroll it the following way: enter the enrolling mode and then enter the 6 digit siren production code (printed in the siren’s manual). The control panel will “request” the siren to send its enrollment signal. The siren will send the signal only if it has no current communication with any other control panel (This protects you from enrolling your neighbor’s siren). Enrollment is completed about five seconds after the code is entered.
- **By pressing the button 8 in the enrolment mode the communication quality of the items can be checked** (LED indicator “battery” will start flashing). After receiving signal from the item the level of the signal is shown on the display from 0 to 10 (corresponding to 0-100% in the ComLink software). In this mode it is also possible to adjust level of audible indications by pressing the button F and

scroll positions of the enrolled items by pressing buttons 1 and 7. Button N exits checking mode.

- **To exit the enrolling mode** press the **N** key

Note: If you do not use JA-60E in your installation, you can enter the learning mode in a different way. Shorten the RESET pins No.K11. This way the JA-60F keypad will be enrolled to the system. You can remove the jumper now.

Note: if an item was not enrolled after its batteries were installed, it is because the control panel recognized its radio signal as a weak one. Items are only enrolled if their radio signal has a level which guarantees reliable communication. Check the detector’s batteries and try to enroll the problematic sensor once more. If it is not accepted by the control panel, you should change the location of the item. All items should be located 1 m or more from the control panel.

11.2. Hard-wired zone input setting

sequence: 60 nn xys

If there is a 65H module in the control panel, wire operated detectors can be connected to the control panel. Setting of the zone inputs is possible by entering: **60 nn xys**

where:

- nn** zone number: 01 to 16
- x** input triggering: 0 = off, 1 = Normally Closed, 2 = balanced loop (EOL resistor 10 kΩ), 3 = double balanced loop (EOL resistors 2x10 kΩ)
- y** reaction: 0 = Instant, 1 = Delayed, 2 = Fire, 3 = Panic, 4 = Tamper, 5 = Next delayed, 6 = control
- s** address to section, 1 = A, 2 = B, 3 = C (shared common section, which is armed only if both A and B sections are armed). If the control panel is not split, select s=1; if you select s=2 then this zone will be automatically bypassed within partial arming. For details about splitting see section 11.23.

Notes:

- If you will not use a particular input, switch it off with x = 0
- Next delayed input (y=5) provides entrance delay only if in the moment of its triggering the entrance delay has been in progress (activated before by any delayed input). If no delayed input is triggered before next delayed, the triggering will cause instant alarm.
- Addressing of inputs to section C when the control panel is not split has the same effect as addressing to B section (i.e. automatic bypass while partial arming is used).
- If y=6 is programmed, then each triggering of this input changes arming status (arm – disarm – arm...) of the entire system or just the corresponding section if the system is split.

Example: to set zone 2 input as a balanced loop with an instant reaction, addressed to A section, enter: 60 02 201

Factory default setting: all hard-wired inputs are switched off.

11.3. Exit delay

sequence: 2 0 x

To change the duration of the exit delay enter **20x** (where **x** represents time in seconds x10). The delay can be selected from 10 to 90 seconds.

Example: to select an Exit delay duration of 20 seconds, enter 202

Factory default setting is 30 seconds

11.4. Entrance delay

sequence: 2 1 x

To change duration of the entrance delay enter: 21x (where x represents time in seconds x10). The delay can be selected from 10 to 90 seconds.

Example: To select entrance delay duration of 40 seconds, enter 214

Factory default setting: 30 seconds

11.5. Alarm duration

sequence: 2 2 x

The alarm duration can be selected from 1 to 8 minutes (or 10 seconds or 15 minutes) entering 22x (where x represents time in minutes, for x=0 the duration will be 10 seconds, for x=9 the duration will be 15 minutes).

Example: to select an alarm duration of 5 minutes, enter 225

Factory default setting: 4 minutes

11.6. PgX and PgY output functions

sequences: 2 3 x & 2 4 x

The control panel outputs PgX and PgY can have different functions, depending on parameter x in the corresponding sequence:

2 3 x – determines triggering of PgX

2 4 x – determines triggering of PgY

If the system is split:

x	23x (PgX)	24x (PgY)
0	Alarm A	Alarm A
1	Alarm B	Alarm B
2	Chime A	Chime A
3	Chime B	Chime B
4	Arm A	Arm B
5	Door A	Door B
6	Panic A	Panic B
7	FIRE	NoAC
8	Phone	Phone

where x represents the following functions (non split system):

- 0 **Chime** – triggered during the entrance delay (pre-alarm output)
- 1 **Fire** – triggered by a fire alarm (by a smoke or a gas detector)
- 2 **Arm** – activated when the control panel is armed (complete & partial arming)
- 3 **Panic** – activated when a silent panic alarm is triggered
- 4 **Alarm** – triggered by any audible alarm (except panic alarm)
- 5 **Door** – activated for 5sec. after  (F3) entering (electric door lock opening)
- 6 **Home** – activated when the control panel is partially armed (Home arming)

No AC – triggered by an AC power failure

Phone/F8 – output can be operated **remotely by phone** or by SMS (if this feature is supported by installed communicator) or locally **from the keypad** by F81 (ON) and F80 (OFF). If a code is requested to operate the system then the F8x instruction should be followed by a valid user code.

Example: the PgX will work as a Panic output when 233 is entered, PgY as Door output when 245 is entered.

Factory default setting: PgX=Chime, PgY=Arm

Note: the control panel also wirelessly transmits the PgX and PgY signals. Wireless output modules UC-216 and UC-222 can be used to receive the signals (see 11.12). The function of the UC module output relays is determined by the 23x and 24x setting.

11.7. Recorded message and phone number editing in the user mode

sequence: 2 5 x

The User mode, which is accessible with F 0 "Master Code", is for bypass setting, system testing and battery replacement. This setting enables the user to change the voice message and telephone numbers of the built in dialer. If the changes are enabled, then programming sequences for number programming, voice message recording and dialer testing are accessible in the User mode. These settings have effect only when the control panel has a 65X communicator module.

options:

2 5 1 changes **enabled**

2 5 0 changes **disabled** (no dialer programming in the User mode)

Factory default setting: changes disabled

11.8. Radio signal jamming testing

sequence: 2 6 x

When this function is enabled, the control panel will indicate trouble if the working band is jammed for more than 30 seconds. Jamming will trigger an alarm when the control panel is armed. Do not enable this testing, if the control panel does not have a 65R radio module.

options:

2 6 1 testing **enabled**

2 6 0 testing **disabled**

Factory default setting: disabled

Note: in some locations the system can be repeatedly jammed for some period of time (near radar, TV or radio station etc.). In these cases the control panel can work without any problems because all important data is repeated, but the jamming test should not be enabled. The level of the signals and interference can be observed using the Comlink software (see 14.)

11.9. Regular communication checking

sequence: 2 7 x

The control panel will check communication regularly with all enrolled items (detectors, keypads, siren etc.) when this function is enabled. If communication is lost with any item, the control panel will indicate the fault of this item (when armed reaction of the system depends on setting 696x, see 11.28). Do not enable this checking, if the control panel does not have the 65R radio module.

options:

2 7 1 checking **enabled**

2 7 0 checking **disabled**

Factory default setting: checking disabled

Note: in some locations with a strong radio interference (near radar, TV or radio station etc.) the communication can be jammed periodically. The control panel can detect such a strong interference as a temporary loss of communication with an item. Even in this case, the system is usually able to work without any problems, because all important data is repeated, but the communication check should not be used.

11.10. Reset enabled

sequence: 2 8 x

The factory default reset (see 13) can be disabled. This way no unauthorized future programming of the control panel will be possible.

options:

2 8 1 reset **enabled**

2 8 0 reset **disabled**

Factory default setting: reset enabled

Note: if the Master or Service code is forgotten when the reset is disabled, the reset of the control panel will be possible only by the manufacturer.

11.11. Controlling of a subsystem

sequence: **2 9 0**

A wireless master control panel receives event signals (alarms, tampering, faults, low battery) from a JA-6x subsystem if enrolled - see 11.1 and 11.12.

This will cause the same kind of event on the master control panel and **J** will be indicated as the source of the event on the keypad.

The master and slave control panels can be either armed and disarmed as two independent systems or the slave system can follow the arming and disarming of the master. If the master should rule arming of the slave subsystem, make the following settings:

- enroll a subsystem to the master's **J** position,
- place the master panel into the programming mode (P is indicated),
- enter the enrolling mode in the sub-control panel (pressing key 1 while in the programming mode)
- enter 290 on the master control panel – this way the master will be enrolled to the slave sub-control panel as a wireless controller (to the first free position of c1 to c8)
- turn both systems to standby mode and check that the subsystem will be armed (in 2 seconds) after arming of the master control panel. Check the same for disarming

Notes:

- Master control panel generates wireless commands Arm and Disarm the same way as a remote control RC-40. The control panel transmits these commands only if it has a subsystem enrolled in its position J.
- The Arm command is generated when the master control panel is completely armed and also at the end of an alarm while the system remains completely armed (automatic alarm timeout). The Disarm command is generated when the master control panel is disarmed, when it is partly armed (home arming or one section arming if it is split) and also in the end of an alarm while the system is disarmed (manual termination of the alarm).
- The subsystem can also be operated by its other controllers (remote controls, keypads) if there are any. For better understanding you can simply imagine, that the master control panel is just another remote control.

Controlling of the subsystem by the master control panel **can be disabled** by erasing the corresponding cN position in the sub-control panel. For example if the master control panel was enrolled to position c3, scroll to this position in the enrolling mode and holding key 2 will erase the master control panel as a controller.

11.12. Enrollment of the control panel to a UC-2xx or to a master control panel

sequence: **2 9 9**

The control panel can send wireless data to output modules UC-216, UC-222 and UC-260. It can also work as a subsystem of another JA-65 or JA-60 control panel.



Enter the enrolling mode of the **UC receiving device** and then enter **299** and the control panel will transmit the enrollment signal.

If you want to enroll a **subsystem** to your control panel, enter the enrolling mode on the MASTER control panel (see 11.1.) and then enter sequence 299 in the programming mode of the sub control panel.

If the system is split the sub control panel enrolls to the common shared section.

11.13. No code requested for , , , (F1, F2, F3), F4, F8 & F9

sequence: **3 0 x**

If this parameter is enabled no code is requested for functions F1, F2, F3, F4, F8 and F9 (or the , ,  keys on the keypad). When this parameter is disabled these functions (keys) can be used only when followed by a code (Master or User) – see the following table:

Factory default setting: no code requested

Note: this feature is also selectable on the JA-60D wireless keypad and it is independent from the control panel setting.

function / setting	300	301
arming	„code“	F 1
partial arming	F 2 „code“	F 2
door opening	F 3 „code“	F 3
memory reading	F 4 „code“	F 4
Appliance control	F 8 „code“ 0 F 8 „code“ 1	F 80 F 81
message listening	F 9 „code“	F 9

11.14. Partial (Home) arming with (F2) (non split control panel)

sequence: **3 1 x**

In partial arming, the control panel reacts only to detectors addressed to section A (see 11.2 and 11.31) and it ignores the triggering of detectors in section B or C (except smoke and gas detectors). Partial arming can be disabled with this sequence.

options:

- 3 1 1** partial arming **enabled**
- 3 1 0** partial arming **disabled**

Factory default setting: partial arming enabled

11.15. Hard wired siren alarm enabled

sequence: **3 2 x**

The SIR siren output is activated when any alarm is triggered (except silent Panic alarm). The siren indication can be disabled with this parameter.

options:

- 3 2 1** siren **enabled**
- 3 2 0** siren **disabled**

Factory default setting: siren enabled

11.16. Exit delay audible indication

sequence: **3 3 x**

The exit delay can be indicated by the „beeping“ of the keypad (for the last five seconds, the beeping is faster). The audible indication can be disabled with this setting.

options:

- 3 3 1** indication **enabled**
- 3 3 0** indication **disabled**

Factory default setting: indication enabled

11.17. Partial arming exit delay audible indication sequence: 3 4 x

Partial arming with  (F2) provides an exit delay for delayed reaction detectors in section A. The exit delay for partial arming can be indicated by the „beeping“ of the keypad (for the last five seconds the beeping is faster).

options:

- 3 4 1 indication **enabled**
- 3 4 0 indication **disabled**

Factory default setting: indication disabled

Note: when this indication is disabled, the confirmation of partial arming and disarming will automatically be silent, regardless of the 36x setting.

11.18. Entrance delay audible indication sequence: 3 5 x

The entrance delay can be indicated by a rapid „beeping“ of the keypad. This indication can be disabled with this setting.

options:

- 3 5 1 indication **enabled**
- 3 5 0 indication **disabled**

Factory default setting: indication enabled

11.19. Arming and disarming chirps with hard wired siren sequence: 3 6 x

The control panel can confirm on the SIR output arming (1 chirp), disarming (2 chirps), disarming with information in the memory (3 chirps), bypass or not ready component when arming (4 chirps). This parameter sets chirps on.

options:

- 3 6 1 siren chirps **enabled**
- 3 6 0 siren chirps **disabled**

Factory default setting: siren chirps disabled

Note: setting of chirp sounds is valid even if the siren is disabled for alarms with parameter 320. Partial arming is always silent, if sequence 340 is selected. Chirp sounds can also be generated with the JA-60A wireless siren (self-contained setting in the wireless siren).

11.20. Siren alarm in Disarm & Partial arming sequence: 3 7 x

The SIR output can be disabled for alarms during the Disarm & Partial arming of the control panel (while somebody is indoors). If the siren output is completely disabled for alarms with parameter 320, this setting has no effect.

options:

- 3 7 1 alarm in disarm & partial arming **enabled**
- 3 7 0 alarm in disarm & partial arming **disabled**

Factory default setting: enabled

11.21. Wireless siren alarm sequence: 3 8 x

The wireless siren alarm function can be disabled with this parameter. This setting will have no influence on the outdoor wireless siren chirp sound function if enabled in the siren. This setting has effect only when the control panel is equipped with a 65R module:

options:

- 3 8 1 siren **enabled**
- 3 8 0 siren **disabled**

Factory default setting: siren enabled

11.22. Indication of system problems when arming sequence: 3 9 x

The system regularly checks the conditions of all items (detectors, keypads etc.). This setting ensures that the user will be warned with 4 rapid beeps after arming, if any component of the system is not ready for arming. Cause of the problem (for example permanently triggered detector, lost communication etc.) will remain displayed on the keypad. If the user ignores this warning, the system will arm after the exit delay, then an alarm will be triggered and finally the problematic item will be bypassed for this arming period. After disarming in such a mode, three beeps will be generated as well.

When the indication is not selected, the problematic item will be bypassed when arming with neither warning nor alarm.

If a permanently activated detector is deactivated during arming (for example your main door is not closed), the bypass of this detector will be canceled automatically and the detector will be ready to trigger an alarm after it is activated (if you close the door after the system is armed).

options:

- 3 9 1 warning **enabled**
- 3 9 0 warning **disabled**

Factory default setting: warning disabled

Note: if this indication is enabled, the problems will also be indicated if there are any when leaving the programming or user mode.

11.23. Control panel splitting sequence: 690 x

The control panel can be split in to 2 independent sections A and B, with a shared common area C. This way the system can be operated by two independent user groups. In fact the system in this mode works like two independent systems. If the system is split to the sections with this setting, it is possible to address detectors (both wireless and wired), user codes and remote controls to the above sections (see 11.2., 11.31 and 11.32.).

options:

- 6 9 0 0 **no splitting** (partial arming available in this mode)
- 6 9 0 1 **splitting to sections A, B and common C** (C is armed only when both A and B are armed)

Factory default setting: no splitting

11.24. Only first source of alarm is recorded sequence: 691 x

When any item triggers the alarm 4 times in a row the system will bypass it until any other events occurs. But it is possible to set the limit at the incoming events so only the very first event during the entire alarm will be recorded. This function is useful especially if the system contains a GSM communicator in order to decrease quantity of the SMS messages. This setting is valid for all kinds of the alarm.

Options:

- 6 9 1 0 **All sources** of alarm are recorded
- 6 9 1 1 **Only first source** of alarm is recorded

Factory default setting: All sources of alarm are recorded

11.25. Alarm triggered by opened zone when arming sequence: 692 x

If the "indication of system problems when arming" (see 11.22) is enabled, it is also possible to test the status of the detectors after expiring the exit delay. If any item is activated then in case of instant zone the alarm will be triggered immediately, in case of delay zone the entry delay will start.

Options:

- 6 9 2 0** test **disable**
- 6 9 2 1** test **enable**

Factory default setting: test disabled

11.26 Audible panic alarm

sequence: **693 x**

For special cases it is possible to set the audible panic alarm.

Options:

- 6 9 3 0** audible panic alarm **disabled**
- 6 9 3 1** audible panic alarm **enabled**

Factory default setting: disabled

11.27. Next delay wireless detectors

sequence: **694x**

All wireless detectors set to instant zone mode (see relevant detector manuals) can be programmed as next delay detectors which will not trigger the alarm during the exit and entry delays.

Options:

- 6 9 4 0** Next delay **disabled**
- 6 9 4 1** Next delay **enabled**

Factory default setting: Next delay disabled

Notes:

- This programming sequence concerns only wireless detectors. For hard-wired detectors' setting see 11.2.
- Next delay wireless detectors provide an exit/entrance delay only if at the moment of their triggering any one delayed detector has already been activated. If no delayed detector was triggered before the next delayed one, the triggering will cause an instant alarm.

11.28. Communication loss alarm

sequence: **696x**

If the regular communication check function is enabled (see 11.9) it is possible to determine if either an alarm will be triggered or a fault indication will be generated when communication with the detectors is lost and the control panel is armed.

Options:

- 6 9 6 1** Communication loss causes **an alarm**
- 6 9 6 0** Communication loss causes **fault indication**

Factory default setting: Communication loss causes an alarm

Note: if the control panel is disarmed then in the case of lost communication the fault will be indicated regardless of this setting

11.29. Entering the programming mode by SC+MC/UC

sequence: **697 x**

If it is enabled then Master code or User code must follow the Service code in order to enter programming mode.

Options:

- 6 9 7 0** MC/UC must follow SC to open programming mode **disabled**
- 6 9 7 1** MC/UC must follow SC to open programming mode **enabled**

Example: If it is enabled then to enter the programming mode (SC 6060/ MC 1234) must be set: F0 6060 1234

Factory default setting: disabled

Note: it has no influence on the user mode entering (F0 MC)

11.30. Addressing of wireless detectors to sections

sequence: **61 nns**

If the control panel is split (see 11.23.) and is equipped with a 65R module, the wireless detectors can be addressed to sections by entering: **61 nns**

where:

- nn** = wireless detector zone number: from 01 to 16
- s** = section: 1 = A, 2 = B, 3 = C (common section - it is armed only when both A and B are armed). If the control panel is not split, and s=2 (or s=3) is selected, this detector will be bypassed while partial arming.

Example: to address wireless detector zone number 3 to section A enter: 61 031

Factory default setting: detectors 1 - 10 are addressed to A, detectors 11 - 16 are addressed to B

11.31. Addressing of the user codes to sections

sequence: **62 nns**

If the control panel is split (see 11.23.), the user codes can be addressed to sections A or B by entering: **62 nns**

where:

- nn** user code number: from 01 to 14
- s** section: 1 = A, 2 = B

Notes:

- If the control panel is not split, this setting has no effect.
- Master code (MC) can not be addressed. If the system is split, the use of MC will arm all sections if no section is armed or it will disarm all sections if any is armed. If you want to operate only section A with master code, enter F1 MC and F2 MC for section B.

Example: to address user code number 4 to section A enter: 62 04 1

Factory default setting: all user codes (01 - 14) are addressed to section A

11.32. Addressing of wireless controllers to sections

sequence: **63 nns**

If the control panel is split (see 11.23.) and is equipped with a 65R module, the wireless controllers (RC-40, RC-22 and JA-60D) can be addressed to A or B section by entering: **63 nns**

where:

- nn** number of the enrolled controller from 01 to 08 (c1 to c8)
- s** section: 1 = A, 2 = B

Notes:

- If the control panel is not split, this setting has no effect
- For the JA-60F keypad this setting has no effect (its user codes are determined by 62nns setting)

Example: to address controller number 5 to section A enter: 63 051

Factory default setting: all wireless controllers are addressed to section A

11.33. Automatic arming / disarming setting

sequence: **64 nahhmm**

The control panel can automatically arm and disarm for a requested period of a day. Up to ten instructions (time & action) can be programmed in the period of one day by entering: 64 nahhmm

actions' table

a	no splitting	split system
0	no action	no action
1	arm all	arm all
2	disarm	disarm all
3	partial arming	arm A
4	partial arming	arm B
5	disarm	disarm A
6	disarm	disarm B

where:

n	instruction number from 0 to 9
a	action (see the actions' table)
hh	hours (from 00 to 23)
mm	minutes (from 00 to 59)

Notes:

- If any automatic action is selected, it will be performed everyday in the programmed time, following the internal control panel clock (see 11.36.).
- The automatic arming and disarming can be overridden manually anytime (by an user code or a remote control)
- If the control panel is in the requested arming mode before the action time, performance of the programmed action will not change the arming

Example: to program an automatic complete arming of the system at 21:15 everyday enter: 64 0 1 21 15

Factory default setting: all instructions are set for no action

11.34. New service code setting
sequence: **5 nSC nSC**

The Service Code can be used to enter the programming mode. A new Service Code must be entered twice in the sequence to avoid an error. To change the code enter: **5 nSC nSC**

where

nSC is your new Service Code (four digits)

Example: to change service code to 1276 enter: 5 1276 1276

Factory default setting: service code is 6060

11.35. User Mode entering
Sequence: **6 9 9 9**

This sequence is used to switch from the Service Mode to the User Mode, where you can set zones' bypass (see User's manual). You can exit the User Mode by pressing the "N" button. The bypassed zones will remain active after the leaving the User Mode.

11.36. Real time and date setting
sequence: **4 hh mm dd MM YY**

The control panel has a built in real time clock. All events are stored to the event memory including the time of the event. The clock should be set after the installation is completed. Time Setting: **4 hh mm dd MM YY**

where **hh = hours** (24 hr. cycle)
mm = minutes
dd = day
MM = month
YY = year

Example: on Jun. 30 2005 at 17:15 enter: 4 17 15 30 06 05

After the control panel is powered, its internal clock's default setting is: 00 00 01 01 00

Note: detail control panel event history can be viewed with a connected PC using Comlink software.

12. System testing

For testing, the control panel should be in the programming mode - "P" indicated on the keypad (see part 11. how to enter programming). No alarm can be triggered in the programming mode and any triggering of a detector (wireless or wired) will make a beep (press F to select for a loud beep by siren) and the LED display will show for a while which zone was triggered. An enrolled wireless controller or siren signal receiving will be similarly indicated.

- **Some detectors (JA-60P, JA-60N, JA-60B etc.)** have an extra testing mode, which is usually activated for 5 minutes after the detector's cover is attached (see manuals of the particular detectors). If the detector is in testing mode, it will indicate triggering locally, and it will also indicate the triggering on the control panel keypad. Note, that the JA-60P motion detector in normal mode (after 5 minutes testing mode) is ready to send information about next triggering 5 minutes after the previous triggering (this period can be shortened to 1 minute - see setting of the JA-60P detector).
- **Triggering of a detector wired** to the H module is indicated at the control panel keypad for about 2 seconds after the triggering. It means, that if a detector is permanently triggered for a longer period, it will not be indicated. If a double balanced input loop (2x 10k) is used, then the control panel distinguishes triggering of the detector from its tampering.
- **The best way of testing** is via a connected PC using the Comlink software (see section 14). In the service events window you will get a chronological record of all performed tests, including zones setting, quality of communication etc.

The system can also be tested by a user in the user mode (confirmed by a "U"). The user mode is accessible with the Master code. To open the user mode enter **F 0 MC (= Master Code)** when the control panel is disarmed.

13. Control panel factory default reset

If you forgot the control panel codes or you have a control panel which is currently not under factory default setting, perform the following procedure:

- disconnect the power and the backup battery of the control panel and wait for 10 sec.
- connect the RESET jumper N. K11 on the main board
- control panel TAMPER must be open
- reconnect the power, "-" will be displayed on the keypad
- within 1 minute disconnect the RESET jumper
- Disconnect the jumper (if you haven't done it before)
- reset is confirmed with "P" (panel is in programming mode)

Note: this procedure resets the factory default settings (see part 11.). The Master code will be 1234, Service code 6060 and all user codes, wireless detectors & controllers will be forgotten. All telephone numbers for voice message and Pager dialing will be erased in the 65X communicator. The reset will not erase event memory and information about the reset will be recorded there.

Warning: if the Master code is forgotten when reset is disabled (with sequence 280), the control panel reset will be possible only by the manufacturer.

14. Personal Computer Interface

The JA-65 system can be connected to a Personal Computer (PC) locally, using the PC-60A (Com port) or PC-60B (USB port) interface cable. If JA-65X module is installed, then it is also possible to dial into the system from a remote PC using the JA-60U modem (see JA-65X). Comlink software is available for Windows system.

User can check and operate the JA-65 system easily via their PC, can read complete events memory with all details, can view the map of the installation (seeing topical triggering of the

detectors) etc. However, the user can not change settings of the system.

Installer who has access rights can program the system, can check the communication quality of the items, can view the level of interference in the location etc. There is also a convenient tool to make a map of the installation, which includes a library of components.

Depending on your access rights, the Comlink software will allow you to open the corresponding screens (see following examples). There is a comprehensive help file in the Comlink program.

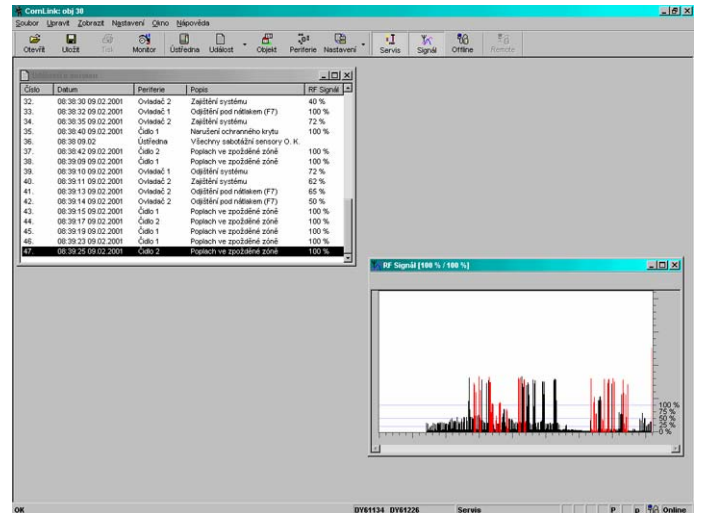
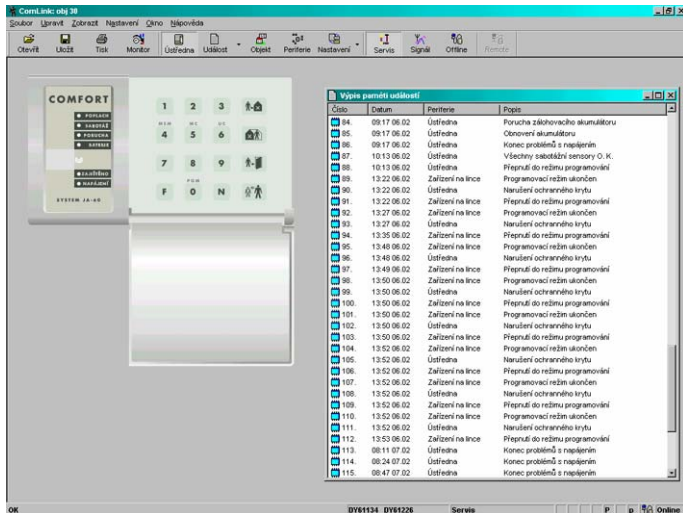

"virtual" control panel access & complete events list

item testing window & RF signal oscilloscope

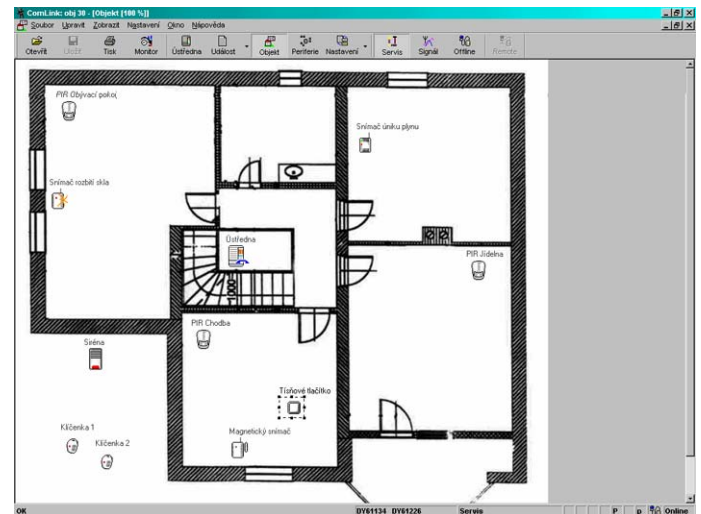
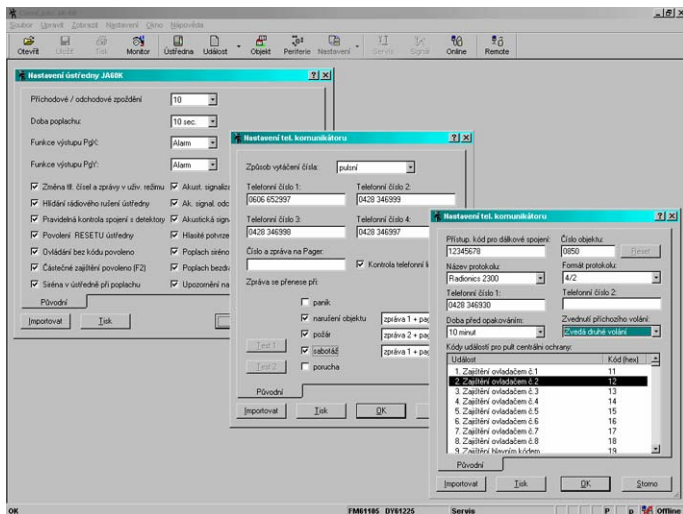

programming dialogs

map of the system (shows current conditions in the house)

15. Recommended Professional installer basic rules

If you install the system for a customer, you should follow these rules:

- make a drawing of intended location of the items, keeping in mind proper protection for the intended area.
- if the customer requests reduction of the system (price reasons etc.), ask for a written confirmation that he does not want the particular items you recommended (to avoid blame and liability if poorly covered area is robbed in the future)

- make a professional installation and do not forget to clean and be tidy.
- it is very important to explain to the customer all functions of the system, to teach to him or her how to program access codes, how to test the system and how to replace batteries in the items
- offer your regular assistance for testing and battery replacement (we recommend annually)
- make a written report signed by the customer, that the installation was finished properly and that she or he received your training on how to operate and test the system

16. Trouble shooting table

Problem	possible cause	solution
alarm after first powering	the control panel is not in factory default setting	perform a factory default reset
connected JA-60E keypad has no function	connecting cable does not connect the corresponding positions in the keypad and in the control panel (1-1, 2-2, 3-3, 4-4)	Check the colors of the cores in the cable and positions on each side
impossible to enroll a wireless item	location of the item is not suitable and the radio signal level is too low (too far away or an obstacle is in the way of communication)	change location of the item, (fix it in the new place temporary at first and then try it)
a fault is indicated on the keypad and it is beeping	check display for the reason of the trouble. Press key N to disable beeping. The trouble information is stored in the event memory and it can be reviewed entering F4 anytime in the future	check the reason of the trouble in user manual and fix it, or call the installer
If JA-65X is used, telephone line failure is indicated and the phone works as normal	when you make a phone call longer than 15 minutes, it is interpreted by the system that the tel. line is not ready.	if this problem repeats, disable tel. line checking in programming mode
PIR movement detector repeatedly triggers alarms with no visible reason	check if there are: animals in the protected area (mice...), sudden changes of temperature or intense air circulation, movement of objects with temperature of about 37°C etc.	increase detector's immunity (internal setting), change location of the detector or use an optional sensor's lens
fault or alarm C is indicated	blown fuse in the control panel or radio communication jamming	PC with Comlink SW gives details
system does not communicate with connected PC	the PC-60A cable is not connected to the correct COM connector on the PC	check the connection or select the port number in SW manually
problem is not in this list	call installer or the distributor for advice	local hot line number:

17. Possibilities to extend the system

The JA-65 alarm system is a kit which can be tailor configured according to the size of the house or the needs of the user. It can combine wireless and wire operated components.

17.1 Extension of the system with a subsystem

An additional JA-65 or JA-60 control panel can be enrolled as a subsystem to the control panel (see 11.12.). Each system then works as an independent system. However, any event in the subsystem (alarm, tampering, failure or low battery) will trigger the same kind of event on the main control panel (the main control panel will display "J" as the event source). The main control panel will not indicate the number of the item which triggered the event, but this information is available on the subsystem's control panel.

Using this method, multiple level subsystems can be chained.

Warning: never enroll the top level control panel as a subsystem of the lower level control panel. This would create endless circle for the data and such an alarm system chain would not work properly.

17.2 Extension of the system with a communicator

GSM communicator JA-60GSM

By using GSM communicator JA-60GSM you will get supervision over the system wherever you are. Communicator sends SMS messages, calls to predefined telephone numbers and plays audible warning, communicates with 2 CMS, allows remote access from a phone's keypad and can be set and operate via web page www.GSMlink.cz.

Digital communicator JA-65X

Communicator JA-65X can communicate with a Monitoring Station, send two voice messages, send five SMS messages via SMS server (if it is supported in your country or dial a numeric Pager). It can also communicate with a remote PC (using ComLink SW and a JA-60U modem). By remotely connected PC it is possible to set and/or operate the control panel.

17.3 Brief overview of parts suitable for the JA-63 system

The brief overview you got along with this manual includes the basic assortment of accessories. Jablotron is systematically introducing new and improved items to the market. You can get the most current information from your distributor or you can visit Jablotron's Internet home page at: www.jablotron.com

18. Control panel specifications:

Electrical

Power	230 VAC, max 0.35 A, (built in electronic power supply), supervised, protection class II
Backup battery	12 V, from 1.3 to 7 Ah (external up to 40 Ah), supervised, not included
Backup power output for wired items	13VDC, the max. permanent current is 0.7 or 1.2 A for max. 15 min (not more than one cycle per hour)
Hard-wired inputs	module 65H: 8 input zones, up to two 65H modules can be used (16 zones)
Zone input triggering	selectable: NC, End Of Line resistor or Double End Of Line resistor
Zone reaction	selectable: instant, delayed, panic, fire, 24 hour, next delayed, control
Modules stand-by consumption	$K=10\text{ mA}$, $H=15\text{ mA}$, $X=12\text{ mA}$, $GSM=50\text{ mA}$, $keypad\ JA-60E=25\text{ mA}$

Wireless communication

Working frequency	module 65R: up to 16 detectors (JA-60), 8 controllers, 1 outdoor siren JA-60A, subsystem 433.92 MHz; digital hopping code; supervised communication
Keypads	max. 5 wired JA-60E keypads, max. 8 JA-60F wireless keypads or RC-40 or JA-60D remote controllers
Access codes	master code and 14 user codes. When system is split, codes, detectors and remote controls can be addressed to particular sectors
Wired outputs	Alarm relay dry contacts 1A/60V; programmable outputs PgX & PgY (Chime, Fire, Arm, Panic, Alarm, Door, Home, AC failure, Phone), siren output (12 V, 0.7 A)
Wireless outputs	module 65R transmits signals for siren and PgX, PgY data for UC-2xx receivers
Events memory	127 most recent events including date, time and detailed specification

Environmental

Operating temperature	-10°C to 40° C
Operating humidity	max 80 %
Working environment	indoor use (class II, EN 50131-1)

Electronic design

Design	SMT; modular system (radio module 65R, hardwired zones module 65H, telephone communicator module 65X); full supervision; monitoring of RF jamming
Electrostatic discharge	8 kV
RF immunity	30 V / m

Physical

Housing	metal box with built-in electronic power supply
Dimensions	295 x 280 x 90mm
Shipping weight	2.72kg
Color	white or light gray

Standards

Complies with: EN 50131-1 (Grade 2), EN 50131-6, EN 300220, ETS 300 683, EN 50136, ETS 300001, TBR 21

** can be operated according to ERC REC 70-03

Hereby, Jablotron Ltd., declares that this JA-65 is in compliance with the essential requirements and other relevant provisions of Directive 1999/5/EC. Original of the conformity assessment can be found at the web page www.jablotron.com, section Technical support.

Note: Dispose of batteries safely depending on the type of the batteries and local regulation. Although this product does not contain any harmful materials we suggest you to return the product to the dealer or directly to the producer after usage.